

Atlantis STS-104

Space Shuttle Program

SSME Flight Readiness Review

June 28, 2001



SSME BLOCK II

June 28, 2001



SSME Engine Comparison

Parameter	Block I	Block IIA	Block II
Power Level	104	104.5	104.5
MCC Pc (psia)	3140	2870 (-270)	2870 (-270)
HPFT Discharge Temp (R)	1694	1601 (-93)	1615 (-79)
HPOT Discharge Temp (R)	1340	1215 (-125)	1223 (-117)

Parameter	Block I	Block IIA	Block II
Power Level	109	109	109
MCC Pc (psia)	3291	2994	2994
HPFT Discharge Temp (R)	1718	1629	1638
HPOT Discharge Temp (R)	1374	1234	1246

Parameter	Block II SSME					
	100	104	104.5	106	109	111
Power Level	100	104	104.5	106	109	111
MCC Pc (psia)	2747	2857	2870	2912	2994	3050
HPFT Discharge Temp (R)	1594	1613	1615	1621	1638	1658
HPOT Discharge Temp (R)	1194	1220	1223	1232	1246	1257



BLOCK I HPFTP

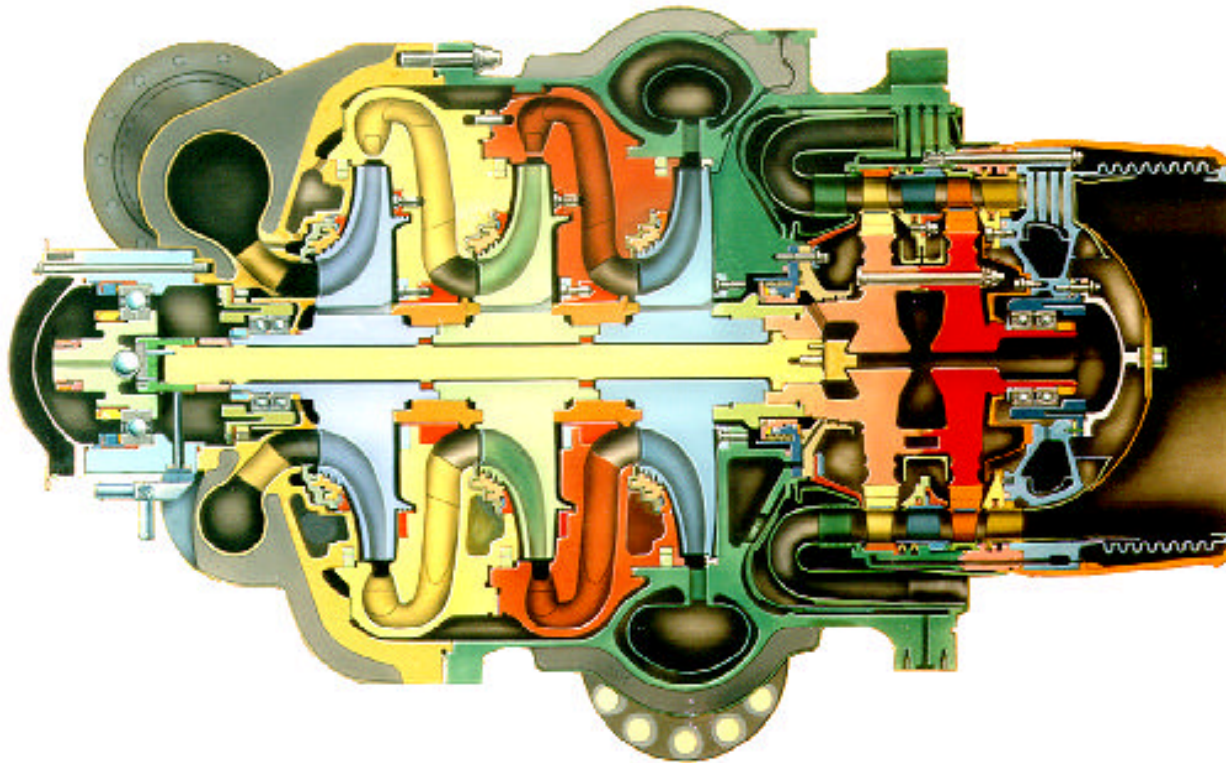



BLOCK II HPFTP-AT

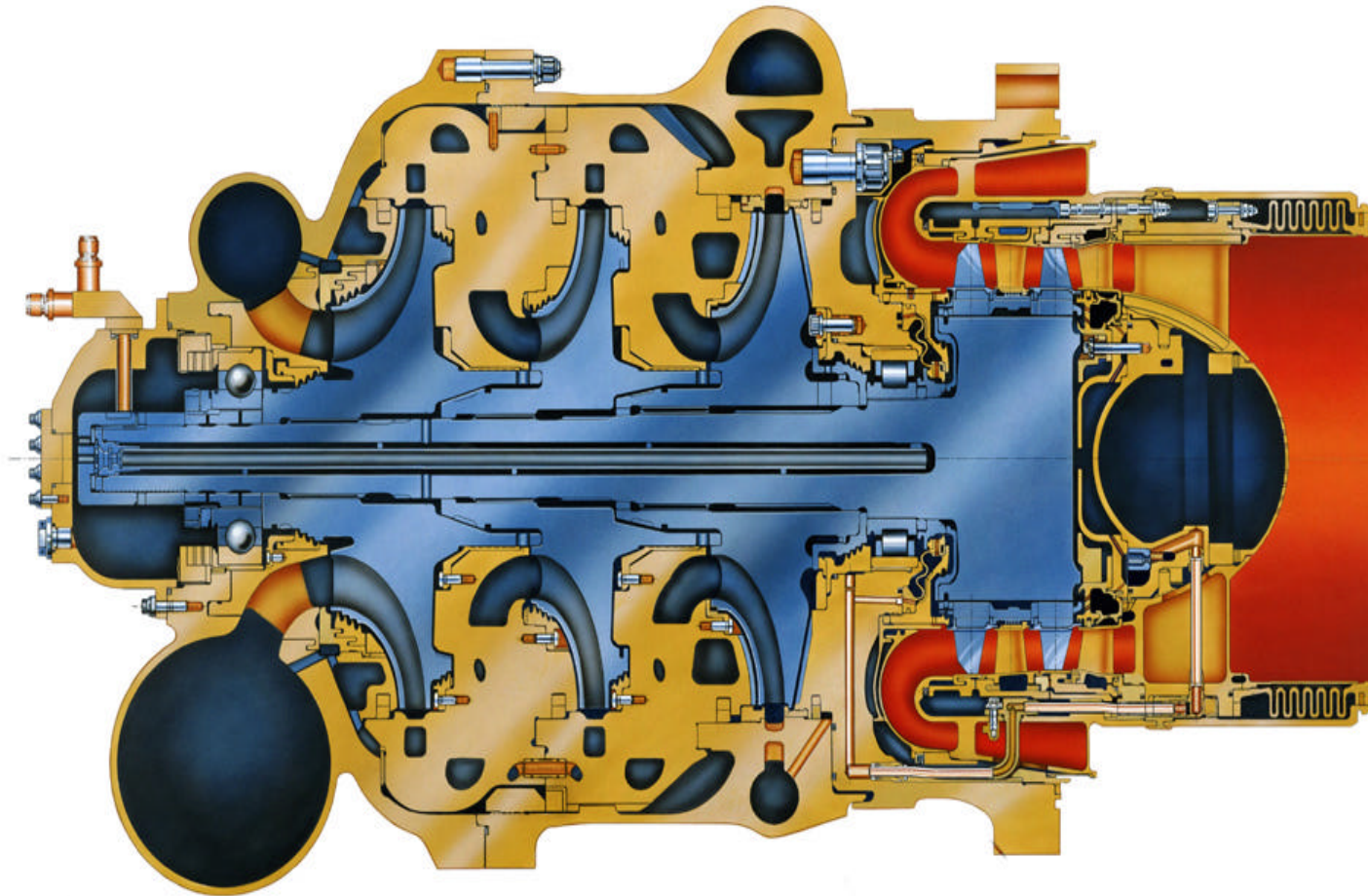

FCD126800

G. HOPSON
28 June 2001



PRINCIPAL CAUSES OF PUMP DAMAGE

- **High Oxygen to Fuel Ratio**
- **Foreign Object Damage**



Blade Cracking Failure – 7/1/96

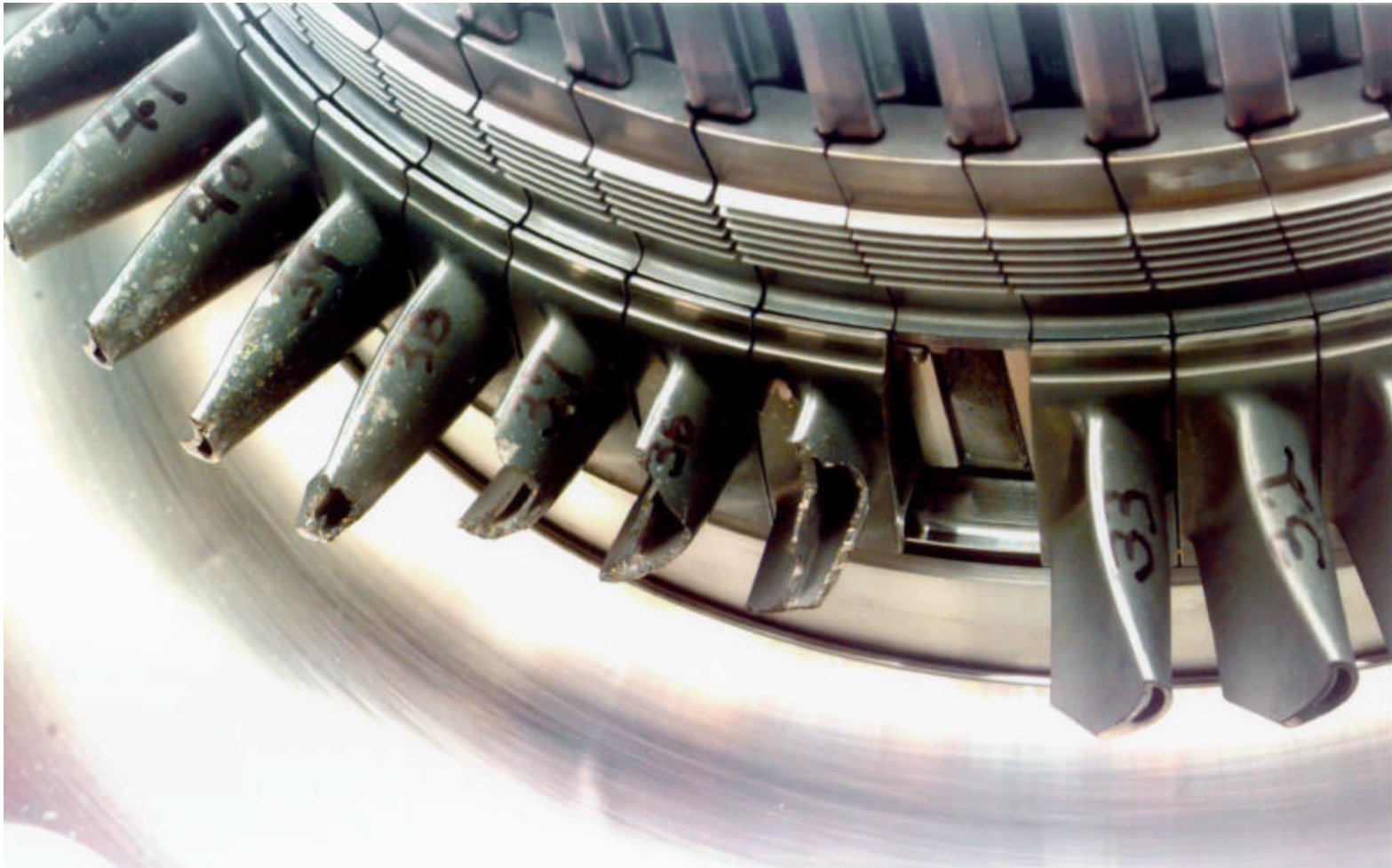

Damaged Turbine Blades (8-1a)



Nozzle Tube Rupture - 8/27/97

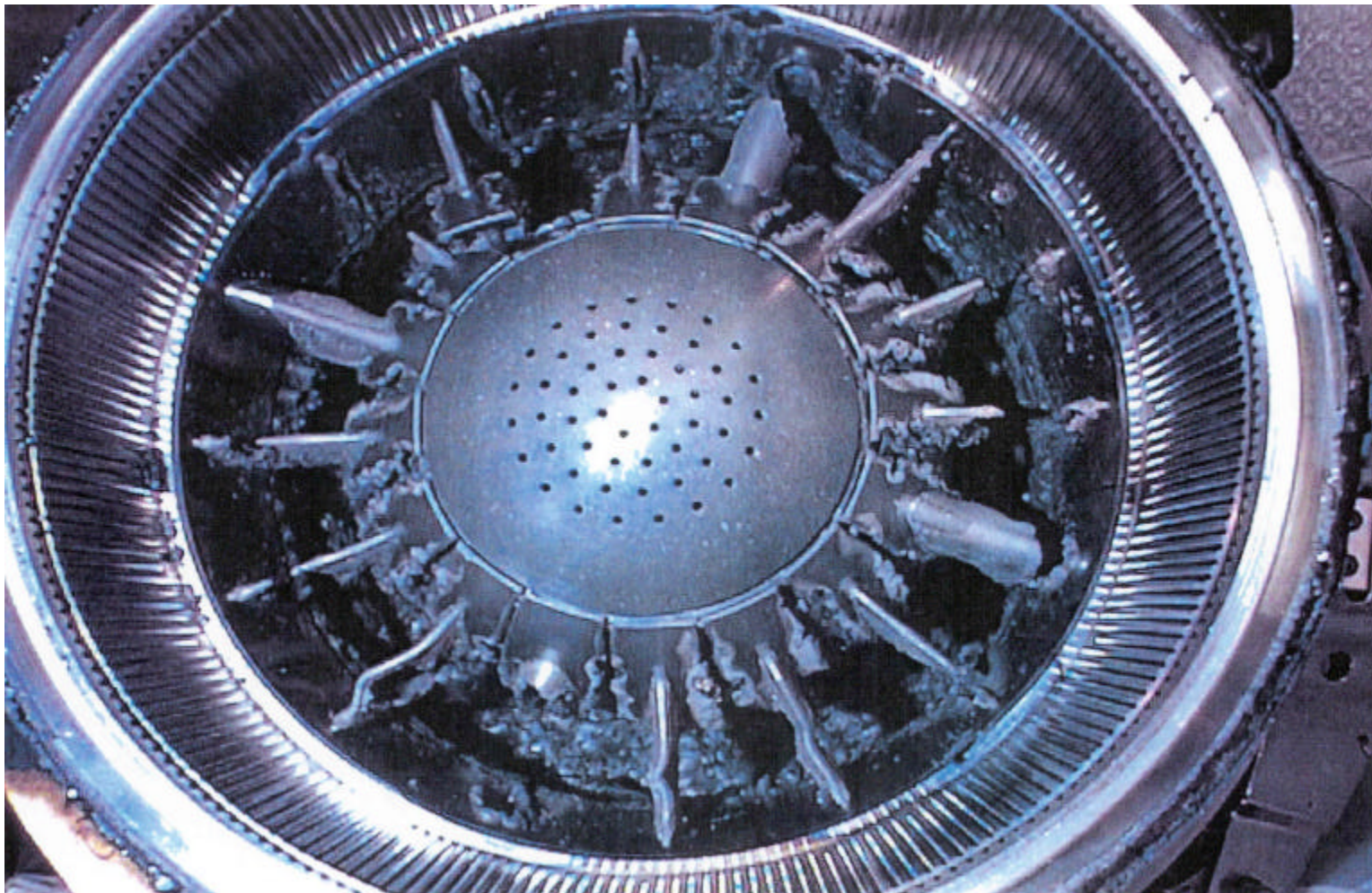

Damaged Turbine - SSME 0524



Turbine Vane Failure – 10/11/97



Damaged Turbine Blades (3-4b)

FED391633



Foreign Object Obstruction in Fuel Preburner - 6/16/00

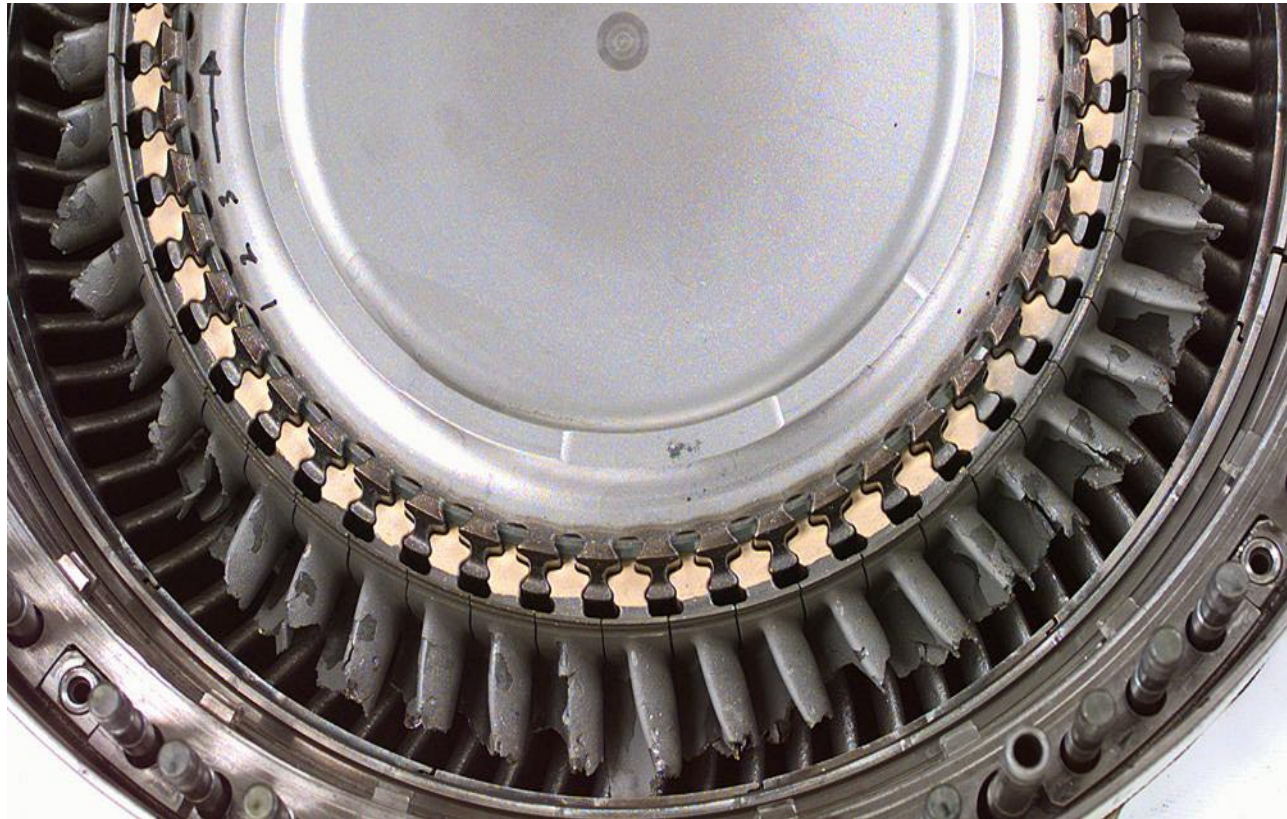

Damaged Turbine - SSME 0523



Atlantis STS-104

Block II HPFTP Implementation Schedule

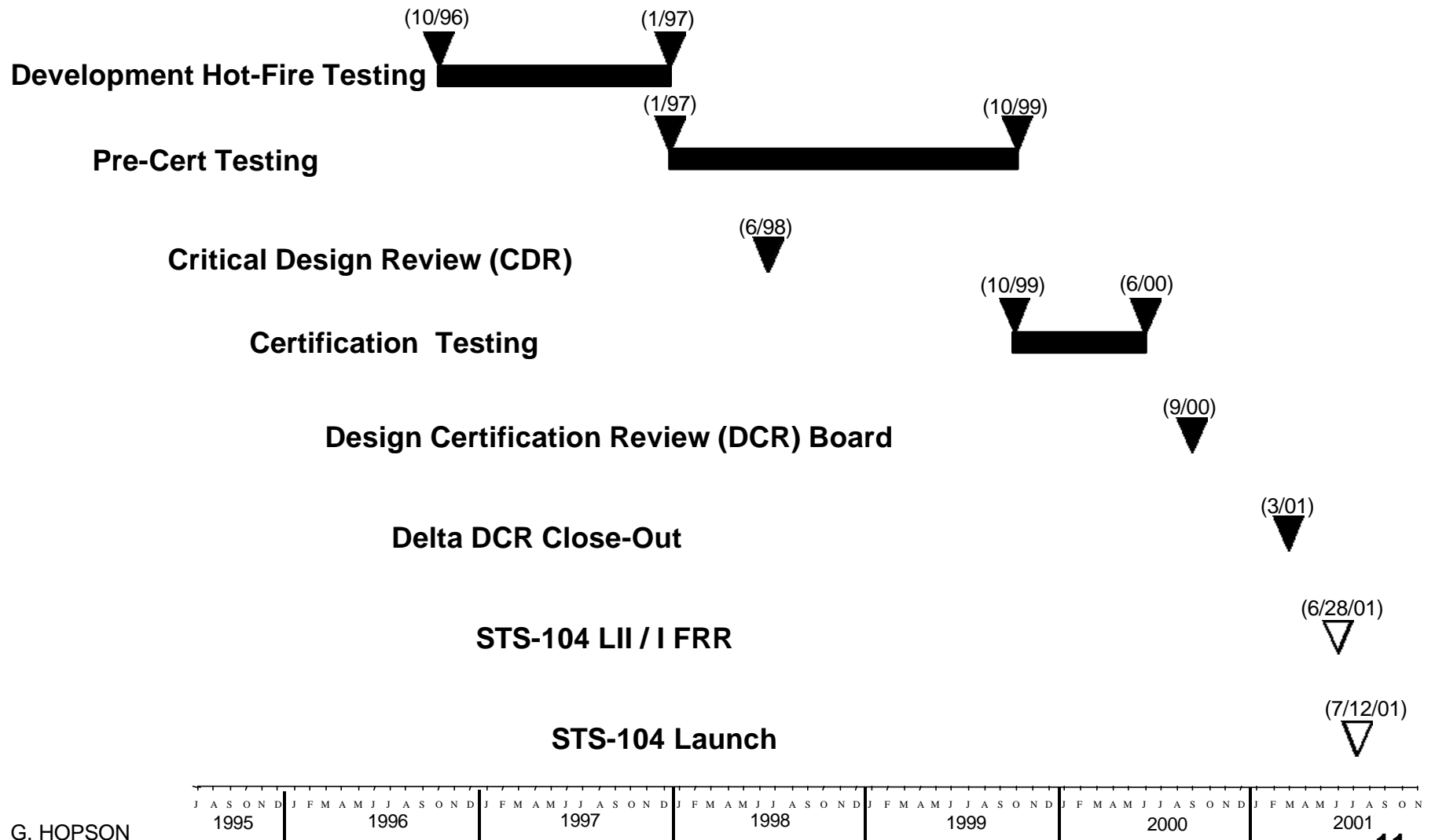



Atlantis STS-104

Block II Design Certification Review Board Members

- **George Hopson, Chairman** (MSFC SSME Project Manager)
- **Bob Sackheim** (MSFC Assistant Director for Space Propulsions Systems)
- **Len Worlund** (MSFC SSME Chief Engineer)
- **Linda Ham*** (JSC Space Shuttle Operations Deputy Director)
- **Lambert Austin*** (JSC Space Shuttle Systems Integration Office)
- **Dave Spacek** (MSFC Mission Assurance Dept.)
- **Chris Singer** (MSFC Space Transportation Directorate)
- **Paul Munafo** (MSFC Materials Process & Manufacturing Department)
- **Joseph Brunty** (MSFC SM&T Department-Structural Dynamic & Loads Group)
- **Jack Bullman**** (MSFC Avionics Department)
- **Christopher Ferguson** (JSC-Astronaut)
- **John Price** (P&W-Alternate Turbopump Manager)
- **Jim Paulsen** (Rocketdyne-VP & Program Manager SSME)
- **Henry Bursian** (KSC-Fluid System Division)
- **Dennis Gosdin** (USA-HSV SSME Manager)

* Represented by Carl Kotila

** Represented by Charles Horne



Atlantis STS-104

Block II HPFTP Key Design / Manufacturing Features

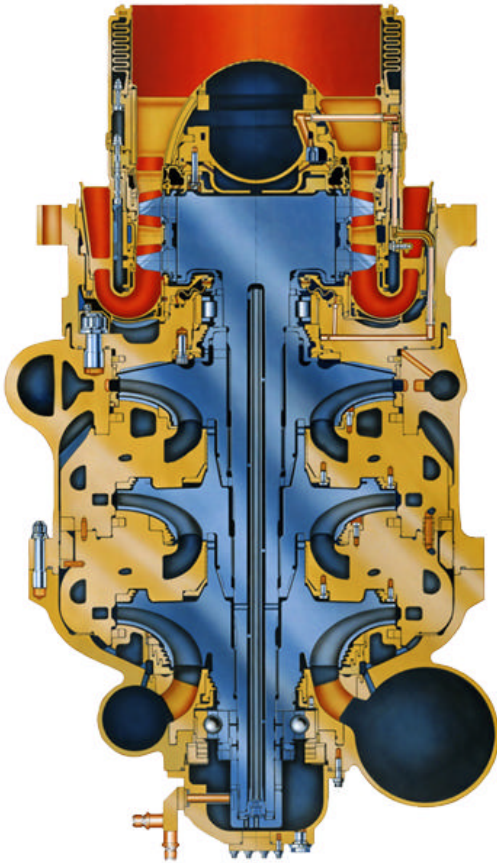

- Extensive use of precision investment castings
 - Elimination of welds and sheet metal flowpath shielding
- Cast INCO 718 Pump Inlet Housing
 - 2X margin on surge / burst failure mode
- Robust bearings
- Stiff rotor and rotor support system
 - Very low synchronous vibration levels
 - Tolerant to induced rotor damage / unbalance (FOD)
- Liquid Air Insulation system common with LPFTP
 - Minimizes maintenance material requirements
- Post-flight bearing drying eliminated
 - No time constraint on general turbine drying
- No coolant liner pressure cavity
 - Eliminated one LCC, Redline and Redline Sensor



Atlantis STS-104

Block II Demonstrated Hotfire Experience

HPFTP/HPOTP Cumulative Hot Fire Time

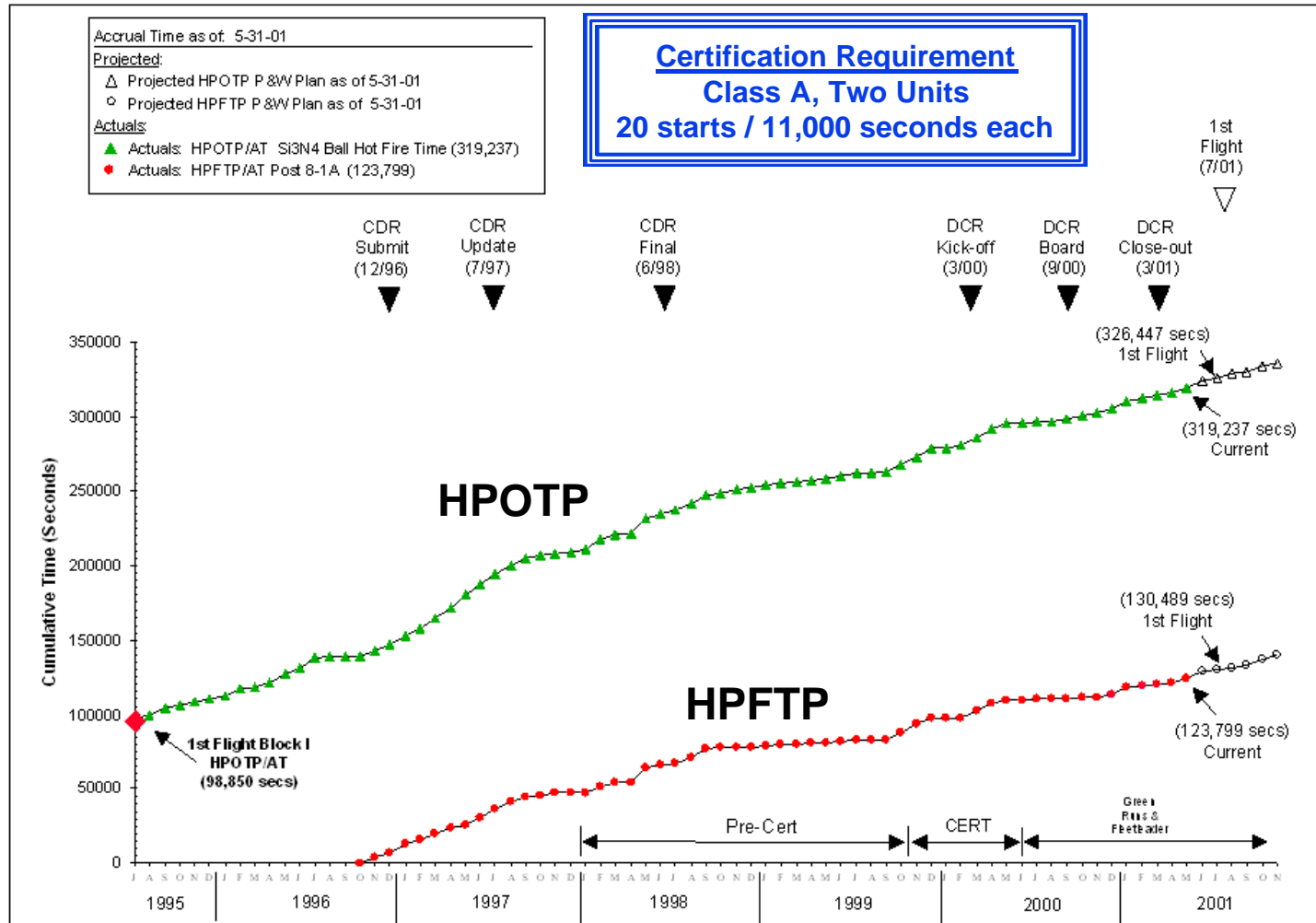



Atlantis STS-104

Block II HPFTP Weight Increased For Ruggedness

	<u>(lbs.)</u>
• Maximum specification dry weight:	1067
• Average measured total dry weight (5 units):	1011
• Margin to spec:	56
• Increase above Block IIA HPFTP dry weight:	236
• Measured Block II HPFTP weight supports Engine Control Weight as defined in NSTS 07700 Vol. X	



Atlantis STS-104

Hotfire Testing Has Been Rigorous

Block II HPFTP Development

(219 starts / 123,799 seconds)

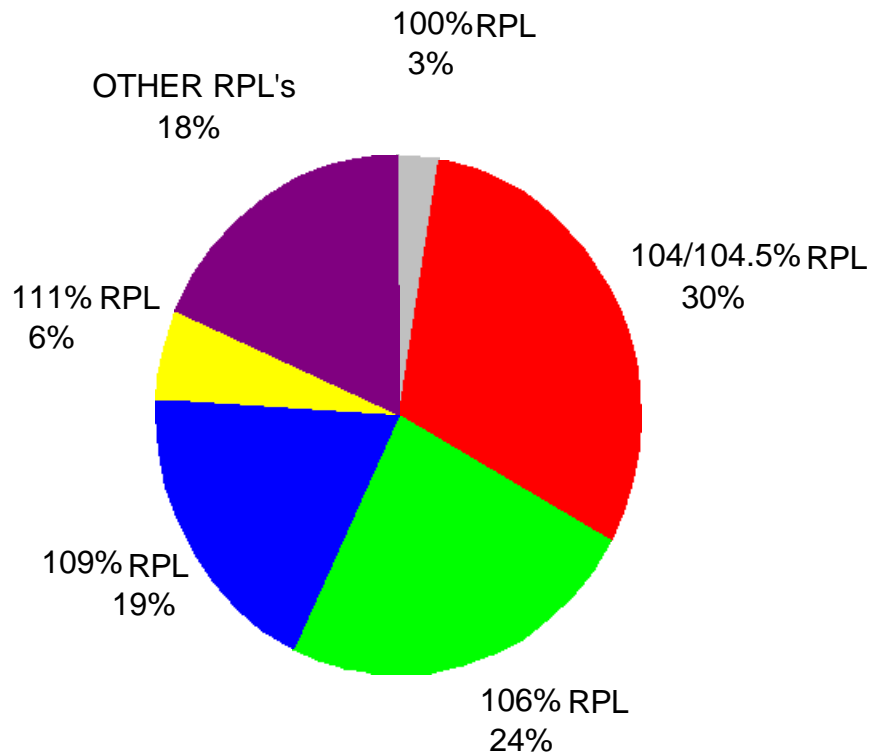

- 49% of testing is above 104.5% RPL

Block II HPFTP Certification

(44 starts / 24,494 seconds)

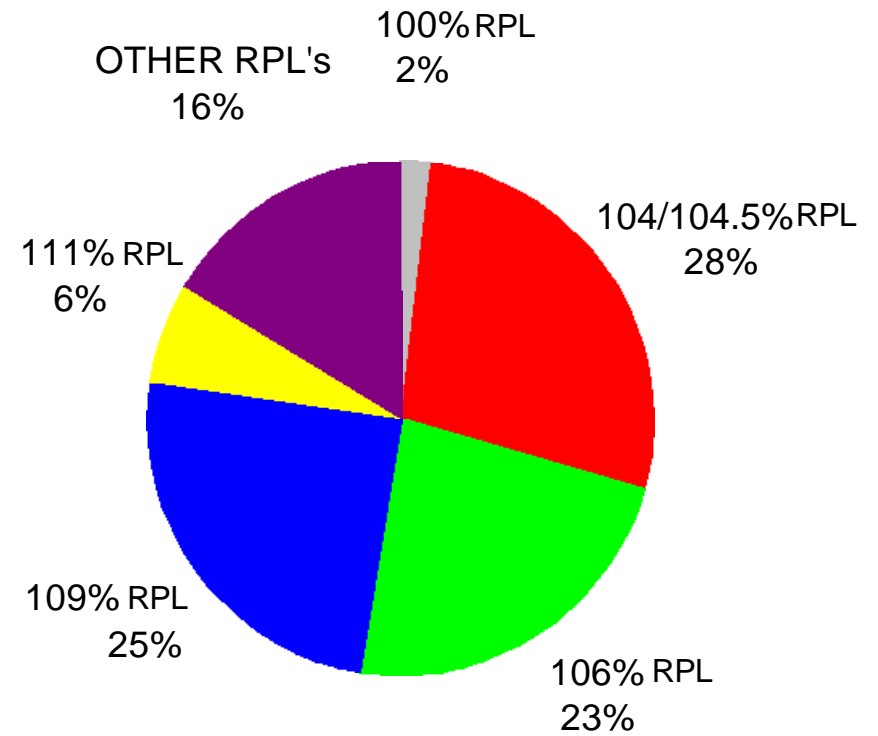

- 54% of testing is above 104.5% RPL



Atlantis STS-104

Block II HPFTP Tested At Flight / Margin Power

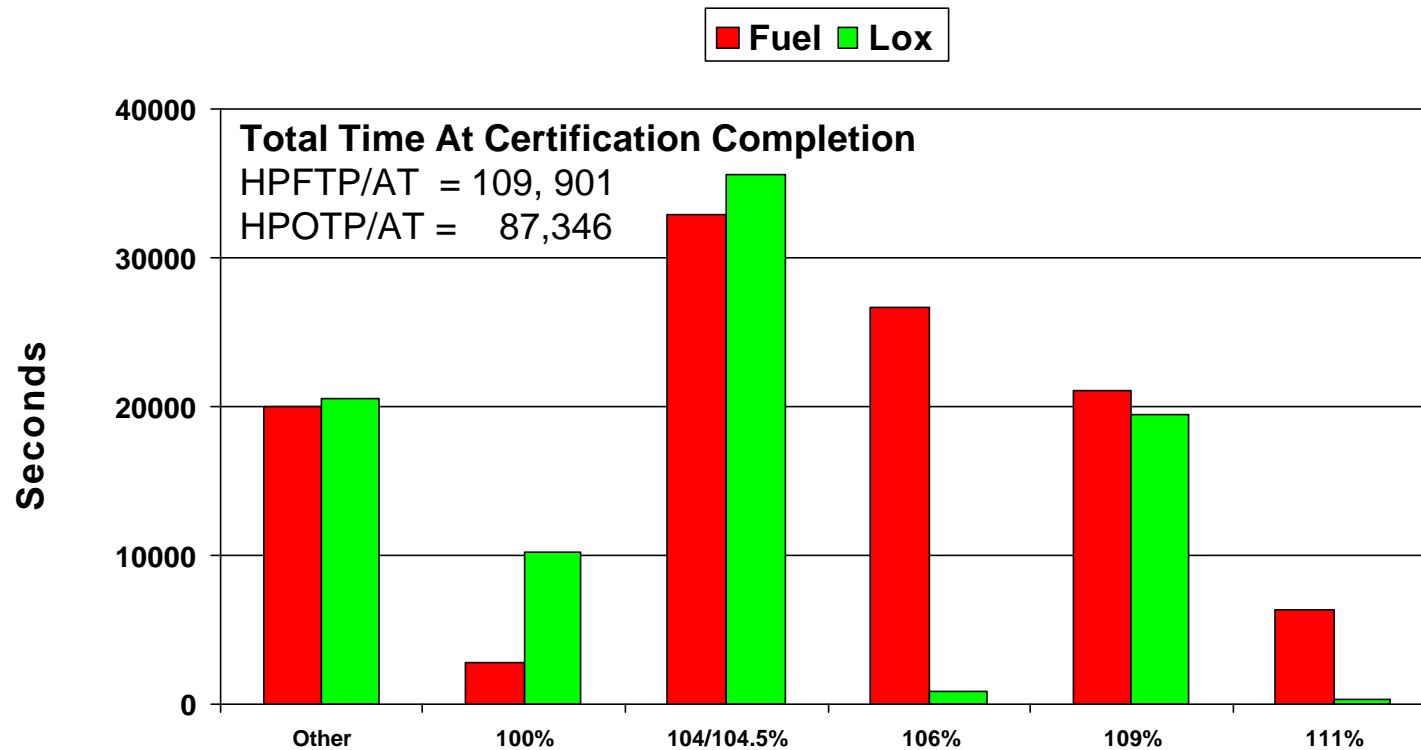

- At Cert completion, HPFTP/AT time at or above 104% RPL exceeds the HPOTP/AT by 54%



Atlantis STS-104

Block II HPFTP Flight Preparation Complete

- **Intensive analytic and subcomponent verification programs complete**
- **Rigorous Development and Certification Hot-Fire Program complete**
- **Technical Issues Closed**
- **Production manufacturing processes validated and frozen**
- **Production deliveries initiated and will support aggressive fleet implementation plan**
- **Ready for flight initiation on STS-104**



Atlantis STS-104

Agenda

- **Major Components**
- **Engine Performance**
- **First Flight ECPs**
- **Special Topics**
 - **Pneumatic Control Assembly Disengaged Nut**
 - **Pressure Sensor EB Weld Mistracking**
 - **E0525 Contamination / Nozzle Tube Ruptures**
- **Material Review Reassessment**



Atlantis STS-104

SSME Major Components

Engine	ME-1 (2056) <i>Block IIA</i>	ME-2 (2051) <i>Block II (2)</i>	ME-3 (2047) <i>Block IIA</i>
Last Hot-Fire	902-776	902-790	STS-98
Powerhead	6012	6018	6016
Main Injector	2036	2035	4027
MCC	6004	6022	6011
Nozzle	2034	5008	4027
Controller	F38	F58	F63
HPFTP	6112 (1)	8016	6114
LPFTP	6106R1	6005	2225
HPOTP	8015R2	8029	8024
LPOTP	4108	6003	2230

(1) Changes from last hot-fire.

(2) First Flight of Block II Engine Configuration



Atlantis STS-104

Predicted SSME Ignition Confirm Margins

Parameter	Margin Sigma		
	ME-1 (2056)	--- Block II --- ME-2 (2051)	ME-3 (2047)
HPFTP Minimum Speed	5.2	3.8	7.1
Min/Max Ignition Pc	5.5	3.6	4.6
Antiflood Valve Min Open	25.7	26.7	25.7
HPFTP Max Turbine Temp	5.3	5.1	4.8
HPOTP Max Turbine Temp	3.0	4.7	3.4
HPOTP Min Turbine Temp	8.9	7.9	8.8
Preburner Max Purge Pressure	26.4	26.5	27.1
POGO GOX Min/Max Pressure	3.4	4.2	3.5



Atlantis STS-104

Predicted SSME Performance at 104.5% P.L.

At Engine Start + 200 seconds
(MR = 6.032, OPI = 69 psia, FPI = 28 psia)

Parameter	ME-1 (2056)	--- Block II ---	ME-3 (2047)
	Sigma	ME-2 (2051) Sigma	Sigma
HPFT Disch Temp A, Deg R	-0.1	b [-2.5]	0.1
HPFT Disch Temp B, Deg R	0.0	-1.3	0.1
HPOT Disch Temp A, Deg R	1.2	1.1	-0.3
HPOT Disch Temp B, Deg R	1.5	c [2.2]	0.9
HEX Interface Temp, Deg R	1.5	1.4	0.5
HPFTP Speed, rpm	0.8	-1.7	0.2
LPFTP Speed, rpm	-0.2	0.7	0.7
HPOTP/AT Speed, rpm	-0.5	2.0	1.2
LPOTP Speed, rpm	1.4	1.9	0.8
OPOV Position, %	0.3	0.1	-0.9
FPOV Position, %	-0.1	-1.5	-1.2
PBP Disch Pressure, psia	1.3	2.0	-0.1
HPFTP Disch Pressure, psia	a [-2.3]	-0.7	0.6
HPOTP Disch Pressure, psia	1.5	1.2	0.1
HPFTP U/N	* 6112	8016	6114
LPFTP U/N	6106R1	6005	2225
HPOTP U/N	8015R2	8029	8024
LPOTP U/N	4108	6003	2230

* Change since last flight / acceptance test

[] Exceeds database two sigma

a Results of low resistance coolant circuit and suspected measurement error

b Result of high HPFP efficiency and large channel delta

c Result of low efficiency HPOTP main pump



Atlantis STS-104

Predicted Redline Margins at 104.5% P.L.

Parameter	Margin Sigma		
	ME-1	ME-2	ME-3
HPFT Discharge Temp ChA, Deg R	6.7	8.7	6.5
HPFT Discharge Temp ChB, Deg R	7.6	8.7	7.4
HPOT Discharge Temp ChA, Deg R	6.3	6.2	7.2
HPOT Discharge Temp ChB, Deg R	7.6	6.8	8.1
HPOT Discharge Temp ChA, Deg R	7.1	7.0	6.0
HPOT Discharge Temp ChB, Deg R	7.3	7.7	6.3
HPOTP IMSL Purge Pr, psia	9.3	5.1	7.1
HPFTP Coolant Liner Pressure, psia	17.6	---	16.7
Low MCC Pc, psid			
Command-ChA Avg	22.5	23.0	22.1
Command-ChB Avg	26.6	27.3	27.5
FASCOS			
HPFTP	16.3	7.8	15.2
HPOTP	33.7	30.3	32.9



Atlantis STS-104

First Flight ECPs

ECP#	Description	Engines
Multiple	Block II and Related Changes	2051
1384	Harness Protective Overmolds	2051 / 2047



Atlantis STS-104

First Flight Of Block II Engine Configuration



- **Integration of Pratt and Whitney HPFTP completes evolution of SSME to Block II configuration**
- **Program Objectives Successfully Met**
 - **Improved Safety Margins**
 - Design focused on elimination of known problem areas (sheet metal, weld joints)
 - **Expanded Operational Capabilities**
 - Certified for operation to 106% rated power level
 - **Reduced Maintenance**
 - No need for turbopump removals between flights
 - Inspections limited to borescope and rotor torque checks



SSME Block II

Improved System Operability & Increased Reliability

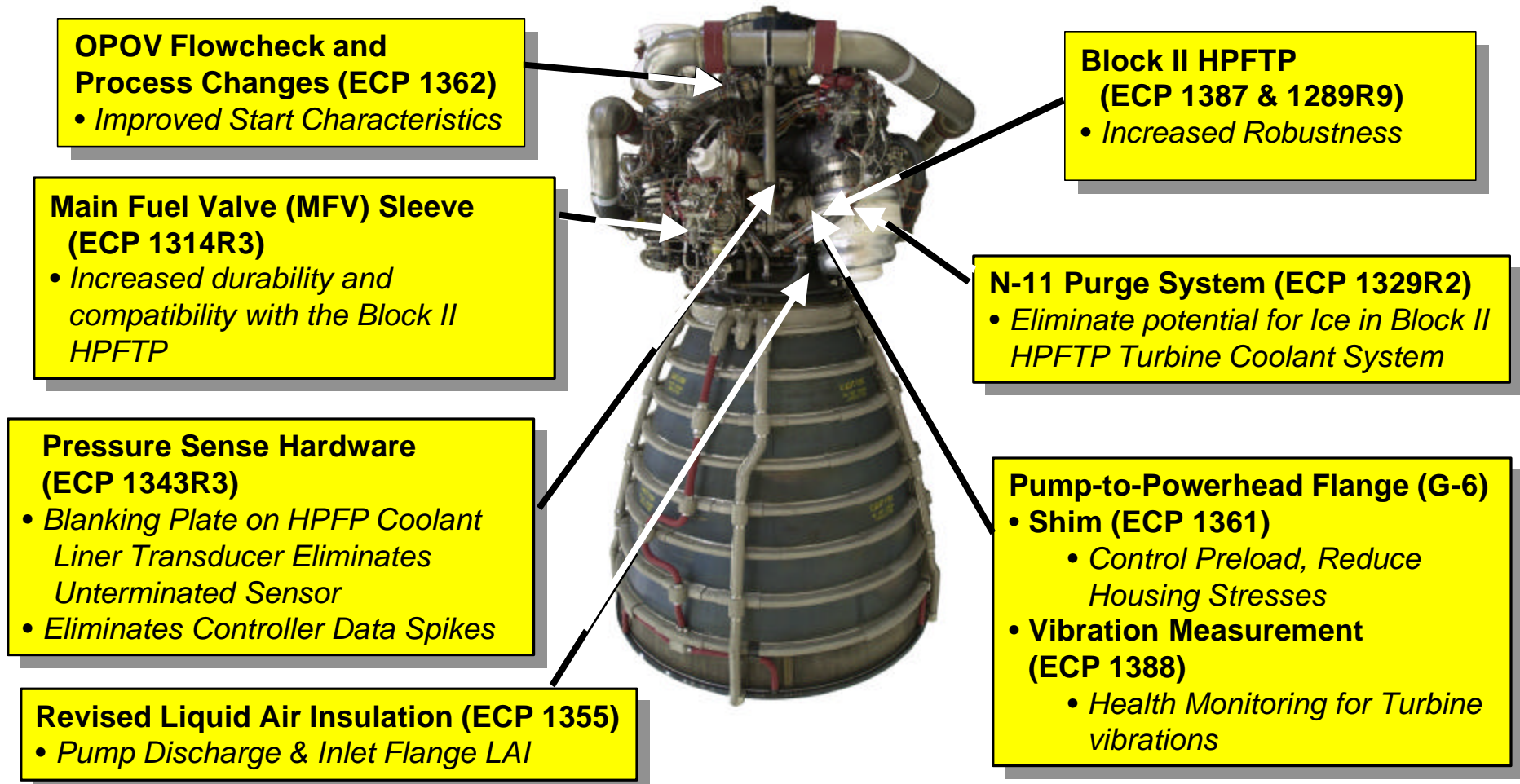



Atlantis STS-104

Block II First Flight Engineering Change Proposals

ECP	Title	Certification Requirement	Certification Status	Total Hot-Fire Time
1289R9	Block II Engine	<ul style="list-style-type: none"> • 40 Starts • 22,000 Secs 	Complete VRS-0560	<ul style="list-style-type: none"> • 242 Starts • 134,395 Secs
1314R3	Main Fuel Valve Redesign	<ul style="list-style-type: none"> • 40 Starts • 22,000 Secs 	Complete VRS-0570/R1	<ul style="list-style-type: none"> • 123 Starts • 69,356 Secs
1329R2	Helium Purge of Block II HPFTP Turbine Coolant Tubes	<ul style="list-style-type: none"> • 20 Starts • 11,000 Secs 	Complete VRS-0569	<ul style="list-style-type: none"> • 48 Starts • 26,313 Secs
1343R3	Unterminated Input Correction: Block II Configuration	<ul style="list-style-type: none"> • 2 Starts • 1100 Secs 	Complete VRS-0585R1	<ul style="list-style-type: none"> • 7 Starts • 2,846 Secs
1355	Block II Revised Liquid Air Insulation for Joints F3 & F4	<ul style="list-style-type: none"> • 2 Starts • Similarity / Analysis 	Complete VRS-0587	<ul style="list-style-type: none"> • 10 Starts • >5,000 Secs
1361	G6 Shim Thickness Change and G5 / G6 Sealing Surface Change for Block II HPFTP	<ul style="list-style-type: none"> • 2 Starts • Similarity / Analysis 	Complete VRS-0595	<ul style="list-style-type: none"> • >48 Starts • >26,313 Secs
1362	OPOV Flow Requirement Change: Bolt Stretch Operation Process Improvements	<ul style="list-style-type: none"> • Similarity / Analysis 	Complete VRS-0583	<ul style="list-style-type: none"> • >123 Starts • >69,356 Secs
1387	Block II HPFTP Flight Configuration Redesigns: N11 Port Plugs, 3 rd Impeller Seal, & 1 st Stage Vane Minimum Thickness	<ul style="list-style-type: none"> • 1 Start - 520 Secs • Similarity / Analysis 	Complete VRS-0599	<ul style="list-style-type: none"> • 13 Starts • 8,018 Secs
1388	Block II HPFTP G6 Turbine Flange Accelerometer	<ul style="list-style-type: none"> • Similarity / Analysis 	Complete VRS-0600	<ul style="list-style-type: none"> • 2 Starts • 1,040 Secs



Atlantis STS-104

Block II Engine Assessment

- **Performance Assessment**
 - Satisfactory operation demonstrated during pre-certification and certification testing
 - Start transient operation
 - Valve sequencing and inlet pressure modifications
 - Mainstage operation – No significant change from Block IIA
 - Shutdown transient operation
 - Valve sequence modification
- **Structural Assessment**
 - Verified acceptable margins (safety factor and life requirements)
 - Engine components re-evaluated based on Block II operating conditions
 - Comprehensive assessment based on extensive hot fire data
 - Including accelerometer and strain gage data



Atlantis STS-104

Implementation Of Block II SSME

- **Block II Planned as Baseline Engine Configuration**
 - First Block II SSME flight on STS-104 (one engine introduction)
 - First full cluster Block II flight: STS-108 (November 2001)
 - All manifests beginning with STS-110 (February 2002) are exclusively Block II engines
 - All Block HPFTP deliveries to be completed before end of CY2002



Atlantis STS-104

ECP 1384: Harness Protective Overmolds

- **Issue**
 - Open Harness Backshells susceptible to damage
 - Nicked wire found during STS-103 aft walkdowns
 - Required Harness R&R on the pad
- **Solution**
 - Install heat-shrinkable overmolds on open backshells
 - Provides complete coverage to protect wiring
 - Same material used on SSME braided harnesses
 - Functional checks verify harness integrity
 - FMEA Criticality 3
- **Certification Status**
 - Certification complete by analysis, similarity and test
 - 4-10 hotfire tests / 2080-5789 seconds on 1 set
 - VCR VRS-0597 approved





Pneumatic Control Assembly

Disengaged Nut and Washer

- **Issue**

- Development engine 0525 PCA aft attachment nut and washer found on test stand deck following hot fire test

- **Background**

- Aft end of PCA attached to powerhead by means of a clevis / pin assembly
 - Pin held in place with washer and self locking nut
- Upper end of PCA bolted in two places to Preburner
 - Torqued and secured with lock wire
- Following test 902-802, PCA aft attachment nut and washer found on test stand deck
 - PCA mounting pin remained in place
 - Test was eighth test (4559 total seconds) since installation of PCA
- No prior history of nut and/or pin loosening
 - Over 2870 starts and 942,000 seconds hot fire exposure



Pneumatic Control Assembly

Disengaged Nut and Washer

PCA / Powerhead Interface

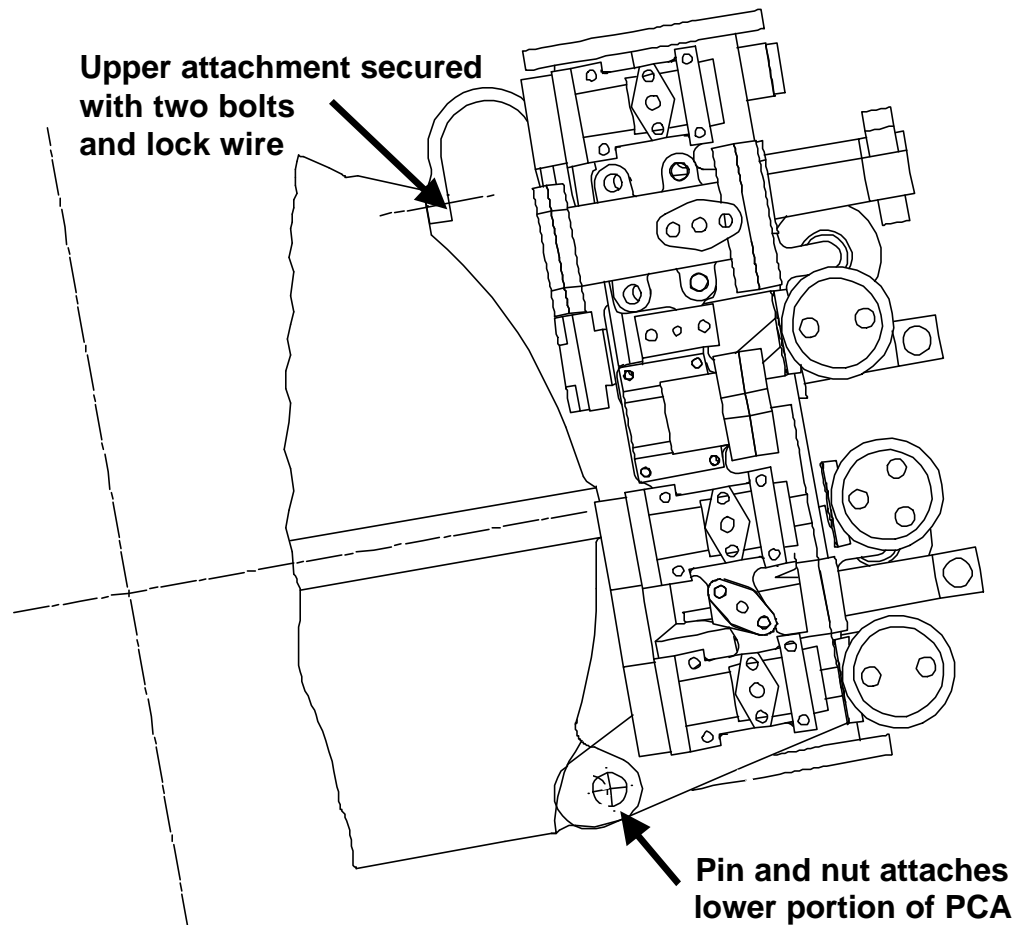

Nut / Pin Interface

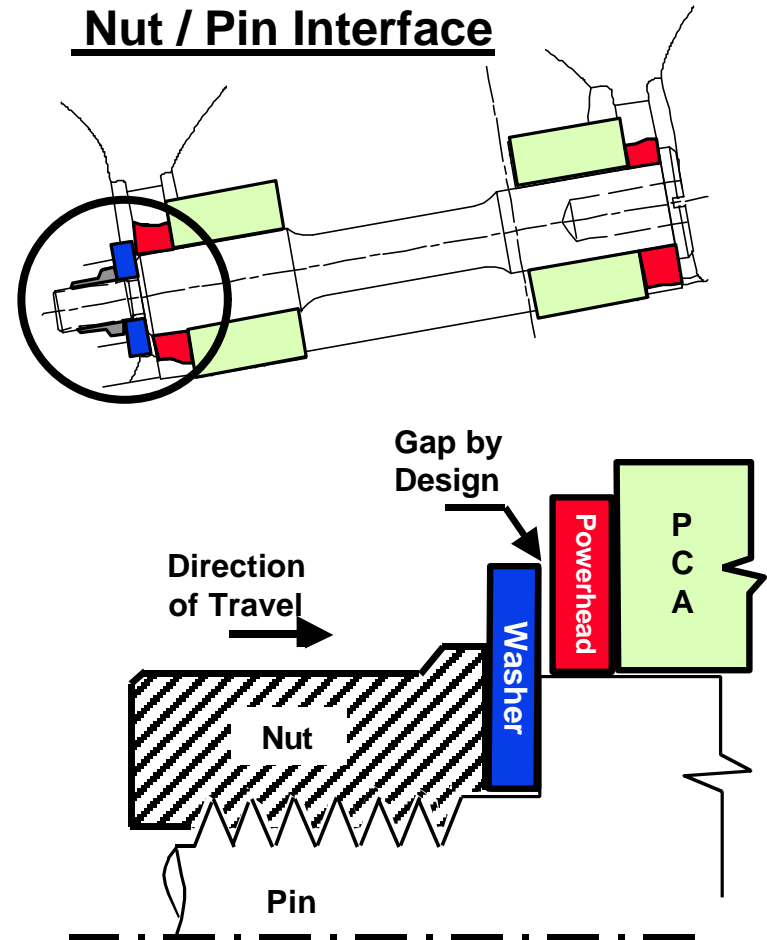



Pneumatic Control Assembly

Disengaged Nut and Washer

- **Rationale for Flight**
 - Torque and bottoming verified on all STS-104 PCA aft attachment nuts
 - No anomalies
 - Extensive successful SSME experience with no anomalies indicates an isolated occurrence



SSME Pressure Sensor

EB Seal Weld Mistracking

- **Issue**

- Pressure sensor discovered with mistracked EB seal weld joint

- **Background**

- Post flight STS-98 data review noted loss of vacuum reference in one of two MCC Pc pressure sensors
 - Channel A - B delta tracked change in atmospheric pressure during ascent (should be constant)
 - Negligible impact on engine performance / mixture ratio
- First occurrence of -300 series pressure sensor vacuum loss
 - 175 sensors: 3,400 starts / 1,889,000 seconds of hot fire
- Original -200 series design contained separate vacuum reference cavity
 - No history of EB weld failures
 - 693 sensors: 17,017 starts / 7,106,000 seconds of hot fire



SSME Pressure Sensor

Configuration Comparison

Original -200 Configuration

-300 Series Configuration

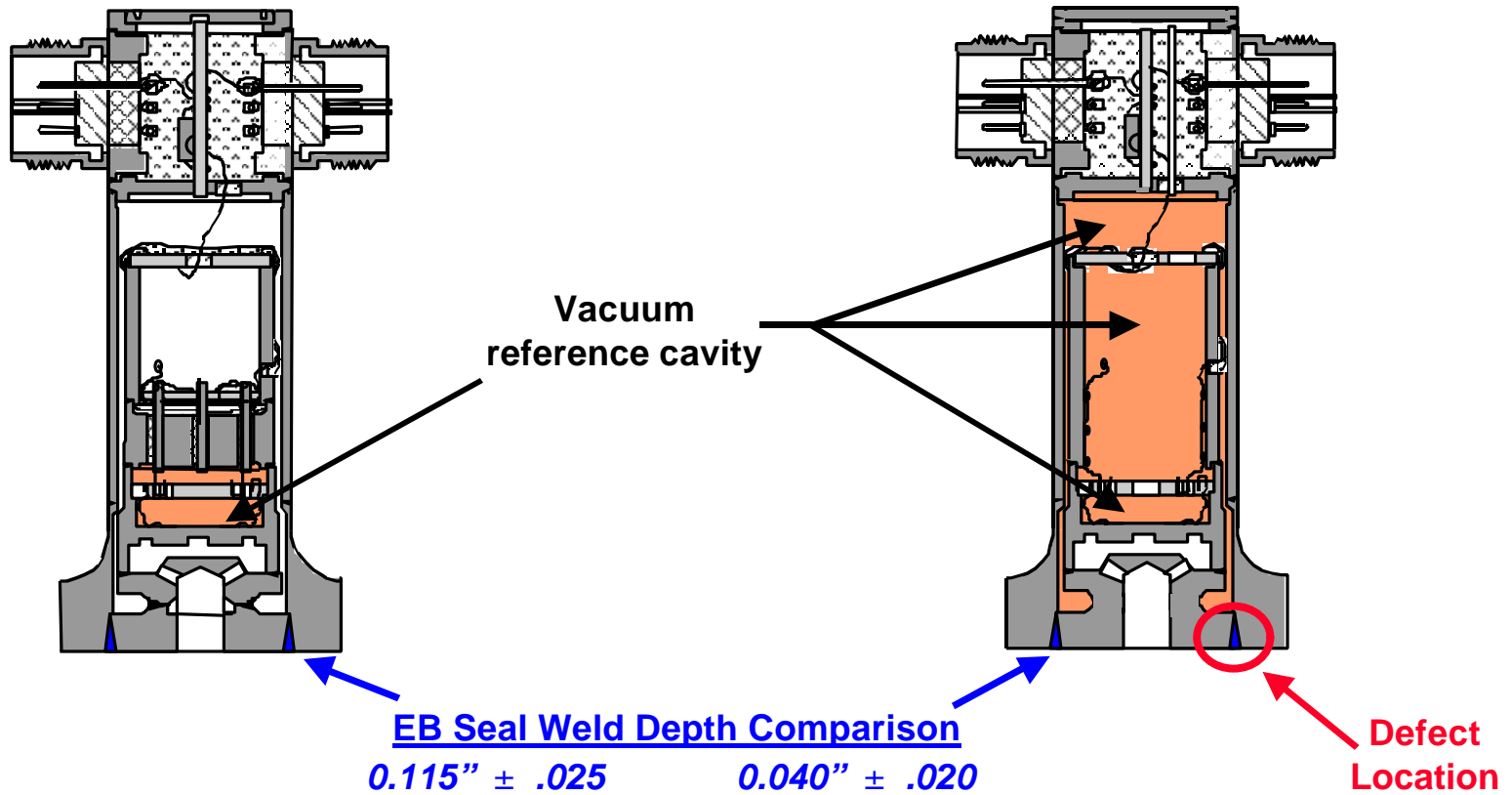



SSME Pressure Sensors

Assessment of Original -200 Configuration Design

- **Design**
 - Weld Penetration Deeper (.090" min vs. .020" min)
 - Normal aspect ratio for EB weld spike produces wider fusion zone
 - More tolerant to mistracking
- **Experience**
 - Extensive hot fire experience with no EB weld failures
 - 693 sensors: 17,017 starts / 7,106,000 seconds
 - Dye penetrant inspection of 24 sensors - no defects
- **Failure Effects are Benign**
 - Leak in seal weld does not result in loss of vacuum reference
 - Secondary header maintains vacuum
- **-200 Series Sensors Acceptable for Flight**



SSME Pressure Sensor

EB Weld Mistracking

- **Immediate Corrective Actions**
 - All -300 series pressure sensors to be screened for flight service
 - Included 13 STS-104 sensors
 - Inspections will verify acceptability for flight
 - Dye Penetrant
 - No surface defects allowed
 - Computed Tomography (CT)
 - Confirm proper tracking and weld penetration
 - “Red Tag” sensor fabrication EB weld process and inspection processes



SSME Pressure Sensor

EB Weld Mistracking

- **Rationale for Flight**
 - All -300 series sensors verified to have proper weld geometry
 - Dye penetrant and CT inspections verified proper tracking and penetration
 - -200 series sensors acceptable for flight as is
 - Weld geometry more robust, less sensitive to mistracking
 - No failure history in 20+ years of service
 - Worst case failure effects are benign



Engine 0525 Nozzle Tube Ruptures

- **Issue**
 - Nozzle tube hot-wall ruptures observed post test 902-795
- **Background**
 - Ruptures indicative of fuel system contamination
 - 8 total ruptures noted in 7 tubes
 - 17 prior occurrences of contamination related tube ruptures
 - Coolant flow blocked, tube overheats and ruptures
 - All Crit 3 failures with no additional engine damage
 - Test 902-795 completed planned 520 second duration
 - No other engine damage



Engine 0525 Nozzle Tube Ruptures

Nozzle Condition Post 902-795

 - Coolant Tube Rupture

View from aft looking forward

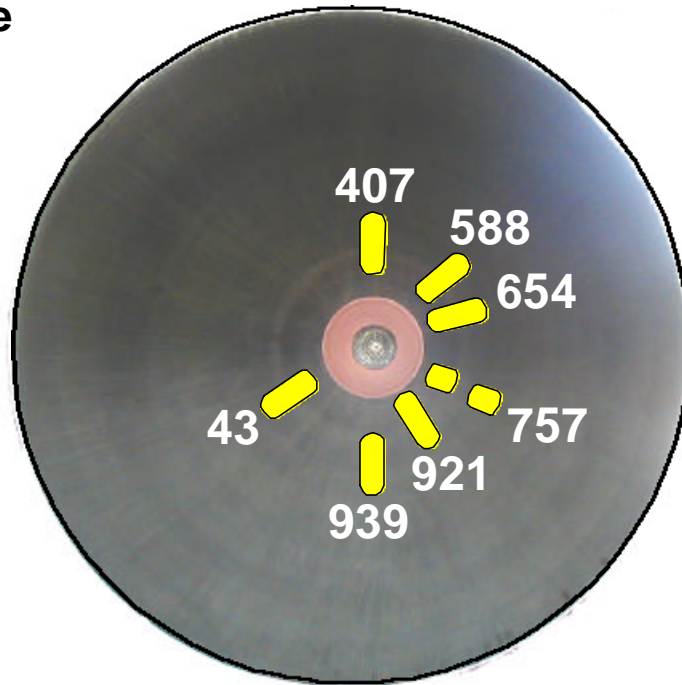

Ruptured Tube

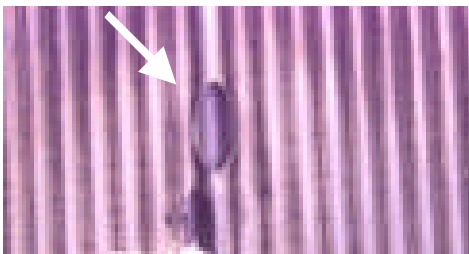

Axial Location of Ruptures

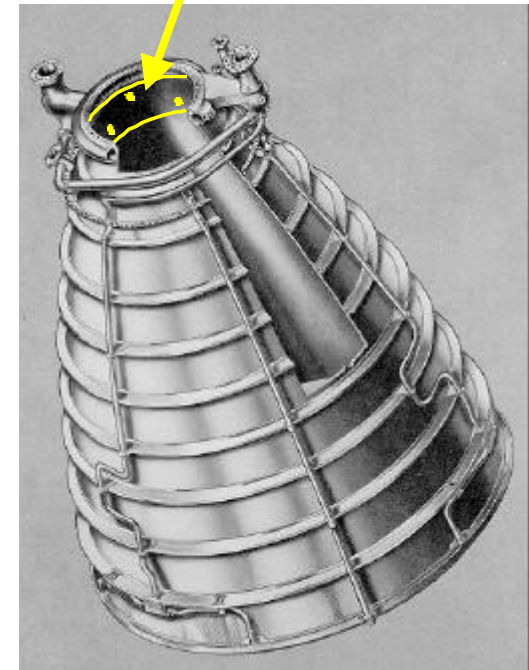



Engine 0525 Nozzle Tube Ruptures

Investigation

- **Contamination observed in turbine and pump inlet and discharge of HPFTP 8018 post 902-794 (ruptures occurred during next test)**
 - Identified as Viton (O-ring material: 3/8" x 3/16" x 1/8" max size)
 - O-ring mold surfaces identified (0.210" cross-section dia.)
- **Subsequent disassembly of E0525 Main Fuel Valve also revealed Viton particles**
 - Dust and particles entrapped within deadheaded cavities
- **No Viton utilized in engine fuel system**
- **Viton O-Rings utilized in GSE (Canoga, SSC and Pratt & Whitney)**
 - Various leak test and flushing fixtures and tooling
- **Search for source ongoing**
 - Cryogenic fracture surfaces verified
- **Next test (902-796) conducted with no anomalies**
 - Additional single tube rupture occurred during test 902-802
 - Likely from residual entrapped contamination



SSME Simplified Schematic

Fuel Side Flow System

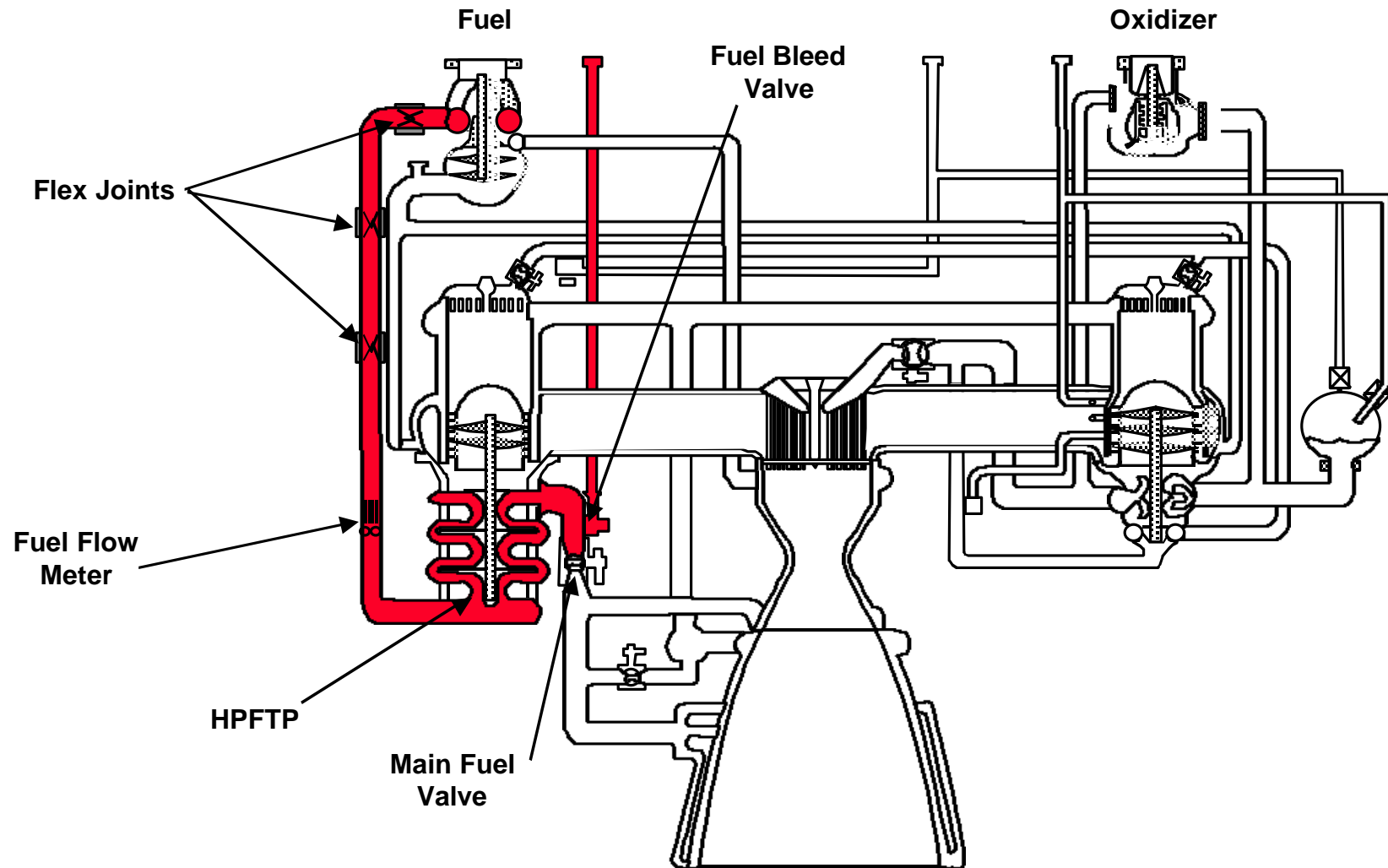



Engine Processing Work

E0525 vs. STS-104 Engines

Ground Test E0525	STS-104, E2056	STS-104, E2051	STS-104, E2047
Components changed pretest 902-794 <ul style="list-style-type: none"> • HPFTP 8015 removed, HPFTP 8018 installed • LPF Duct • HPF Duct • HPFTP Speed Probe • Fuel Bleed Line 	HPFTP 8015 removed, HPFTP 6112 installed Removal of Block II HPFTP purge system	HPFTP 8016 removed and reinstalled following post test inspections	HPFTP 6114 removed and reinstalled following post test inspections

- **All engines had typical post test system inspections**
 - Increased awareness and FOD sensitivity since E0523 incident
 - Borescope inspections of opened joints



Contamination Summary

E0525 vs. STS-104 Engines

Ground Test E0525	STS-104, E2056	STS-104, E2051	STS-104, E2047
Post Test 902-794 Viton particles in HPFTP turbine Viton particles in HPFTP pump	SSC Machining curl in FBP restrictor gap	SSC None	SSC Not applicable
Post Test 902-795 Small particle in F17 - lost during retrieval	KSC None	KSC None	KSC None



Engine 0525 Nozzle Tube Ruptures

- **Rationale for Flight**
 - No contamination found in STS-104 engines during flight processing
 - Minimal opportunity to introduce contamination
 - All turbopumps are green run at SSC prior to flight
 - Potential contamination flushed during ground test
 - Contamination related tube ruptures are Crit 3
 - 19 occurrences in over 2870 starts and 942,000 seconds of operation



Atlantis STS-104

Significant MR/PR Review

	2056		2051		2047	
	MRs	PMRB*	MRs	PMRB*	MRs	PMRB*
Powerhead	117	52	59	35	92	42
MCC	15	10	9	4	18	7
Nozzle	92	44	90	38	69	35
Controller	1	0	0	0	1	0
HPFTP	132	25	187	34	141	33
LPFTP	52	15	23	9	62	13
HPOTP	207	67	146	56	166	61
LPOTP	36	10	36	10	36	10
Assembly Ops	149	67	136	54	125	39
Ducts/Interconnects	104	57	72	52	107	75
Totals	905	347	758	292	817	315

Total PMRB MRs = 954
Total MRs = 2480

*MRs that would meet today's Rocketdyne PMRB criteria

All dispositions reassessed and found acceptable for flight.



Atlantis STS-104

SSME Readiness Statement

- **The Atlantis Main Engines are in a ready condition for STS-104**

G.D. Hopson
Manager
SSME Project

J. S. Paulsen
Program Manager
Space Shuttle Main Engine